



# TSS Associates, Inc.



For further assistance, please contact  
TSS Associates for Tech Support

---

518-621-7283

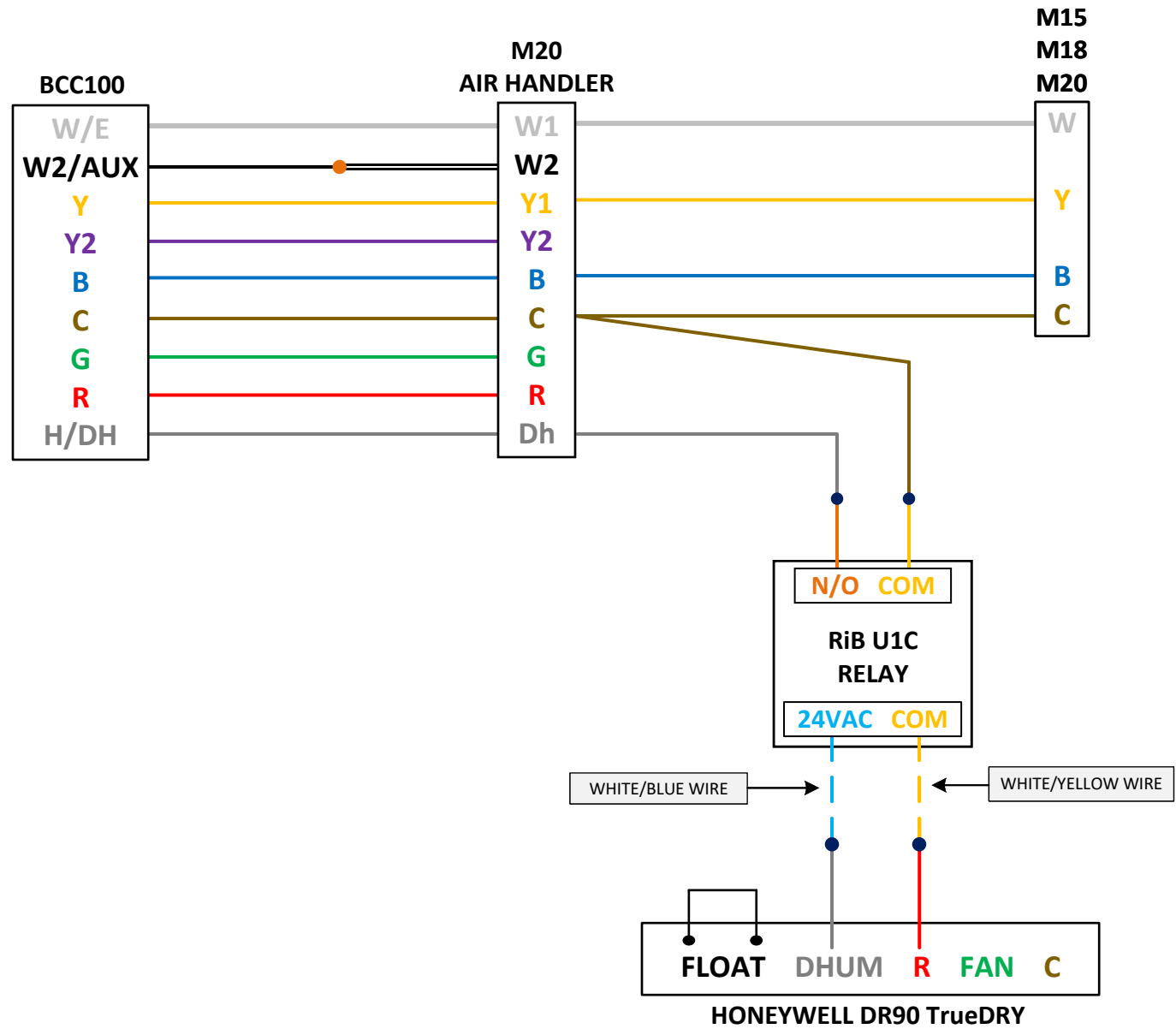

**NOTES:**

Auxiliary/Emergency heat is Electric-strip installed in AHU. Some form of back-up heat is highly recommended to be installed.

**TSS Associates, Inc.**

**DESCRIPTION**

BOSCH BCC100 – IDS – M20 AHU – ADD-ON DEHUMIDIFIER

DATE: 1/4/2024

PAGE: 2 of 3

**PARAMETERS:**

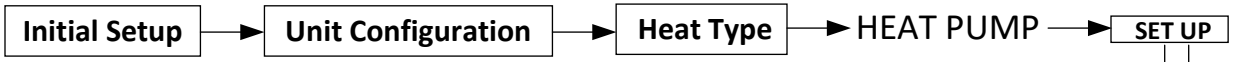

- Reversing Valve - Set to **Energized in Heat**
- Emergency Heat - Set to **Enabled**
- Auxiliary Heat - Set to **Enabled**

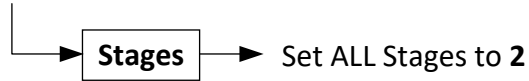

**COOL TO DEHUMIDIFY:**

- Set to **Enable** to active only during a call for cooling
- Set to **Disable** to active regardless of a call for cooling

- You can set a desired RH% Level to be met in MODE by selecting  and then selecting: Automatic Control – **YES**

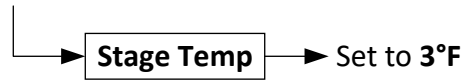
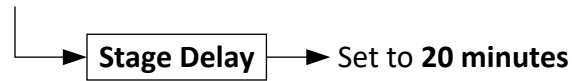
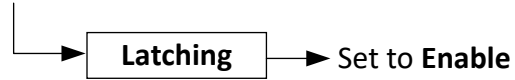

NOTES:

**TSS Associates, Inc.**

DESCRIPTION  
BOSCH BCC100 – **IDS** – M20 AHU – ADD-ON DEHUMIDIFIER