



# TSS Associates, Inc.



For further assistance, please contact  
TSS Associates for Tech Support

---

518-621-7283

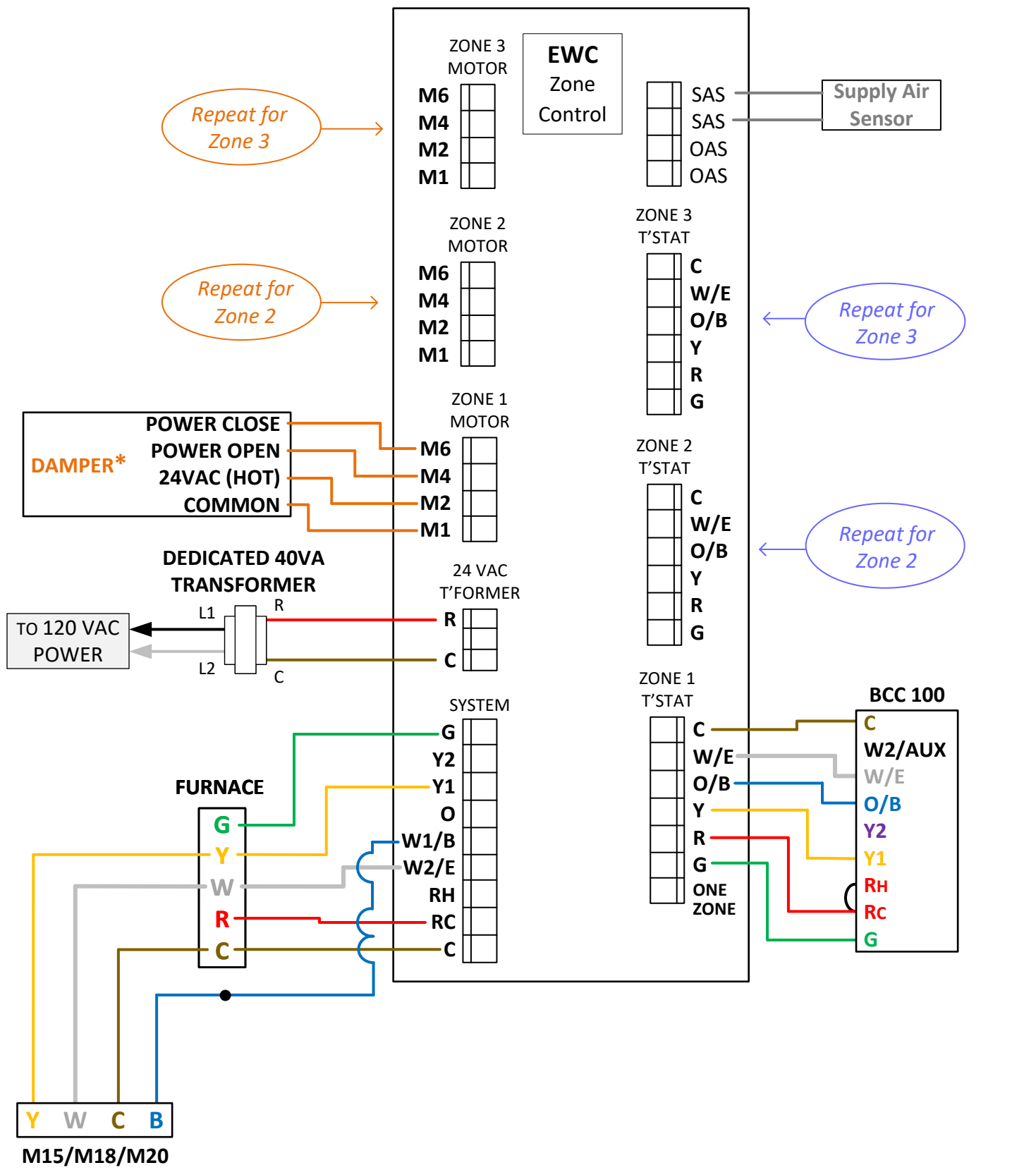

NOTES:

\*If powering more than one damper per zone, a dedicated transformer with isolation relay is required at each zone. Follow the directions in the EWC Installation and Operation Manual.

TSS Associates, Inc.

DESCRIPTION

BOSCH BCC100 – IDS – SINGLE-STAGE GAS/OIL FURNACE – EWC BMP3000

DATE: 1/4/2024

PAGE: 2 of 4

**THERMOSTAT PARAMETERS:**

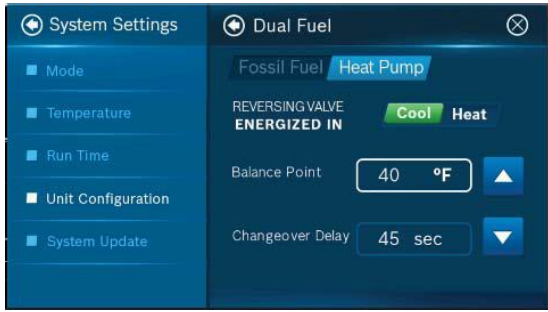

FOSSIL FUEL

FAN CONTROL - Set to **Thermostat**

HEAT PUMP

REVERSING VALVE - Set to **Energized in Heat**  
 BALANCE POINT - Set to **Whatever temperature is desired based upon homeowner comfort and energy costs**

CHANGEOVER DELAY - Set to **45sec**

Stages → Set ALL Stages to **1**

Accessories → Select **None**

Advanced Settings → Installer Access → Enter code **1886** then **ST**

Latching → Set to **Enable**

Stage Delay → Set to **30 minutes**

Stage Temp → Set to **3°F**

Advanced Settings → Heating & Cooling → Enter code **1886**

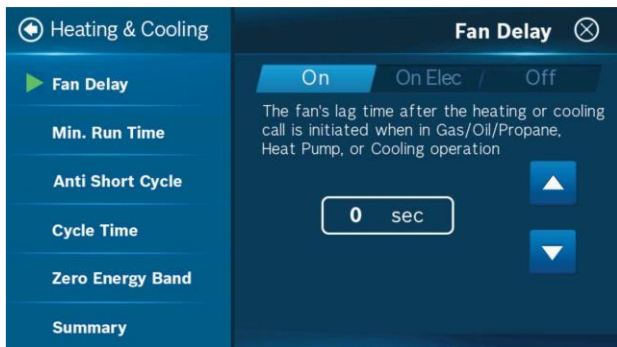

Fan Delay → **On** → Set to **120 seconds**

NOTES:

**Bosch BGH96 Furnace W2 Delay:**

<b>S1-1</b>	<b>S1-2</b>	<b>S1-1</b>	<b>S1-2</b>
<b>ON</b>	<b>OFF</b>	<b>ON</b>	<b>ON</b>
<i>Sets to 10 minutes</i>		<i>Sets to 20 minutes</i>	

**TSS Associates, Inc.**

DESCRIPTION  
 BOSCH BCC100 – **IDS** – SINGLE-STAGE  
 GAS/OIL FURNACE – EWC BMP3000

DATE: 1/4/2024 PAGE: 3 of 4

**ZONE CONTROL PARAMETERS:**

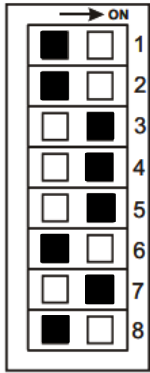

**HP** < SYSTEM > OTHER

**DF** < HP > **CONV**

**HC** < TSTATS > **HP**

**O** < RV > **B**

**OAS** < STAGING > **TIMER**

**OFF** < 50%RULE > ON

**OFF** < SAS > ON

**GAS** < FAN > HYDRONIC

→ Set *Timer* to **OFF**

Set *2<sup>nd</sup> Stage Heat Differential* to **5**

→ Set *Low Temp Limit* to **40**

Set *High Temp Limit* to **140** for Gas, **160** for Oil

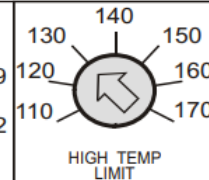
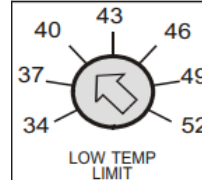
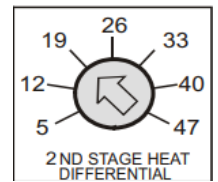
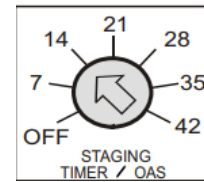

NOTES:

**Bosch BGH96 Furnace W2 Delay:**

**S1-1 S1-2**

**ON OFF**

*Sets to 10 minutes*

**S1-1 S1-2**

**ON ON**

*Sets to 20 minutes*

**TSS Associates, Inc.**

DESCRIPTION

BOSCH BCC100 – **IDS** – SINGLE-STAGE  
GAS/OIL FURNACE – EWC BMP3000

DATE: 1/4/2024

PAGE: 4 of 4