



TSS Associates, Inc.



BOSCH

Invented for life

For further assistance, please contact
TSS Associates for Tech Support

518-621-7283

****IF WIRING MULTIPLE DAMPERS IN SERIES ON ONE ZONE, USE A DEDICATED TRANSFORMER AND ISOLATION RELAY AT EACH ZONE**

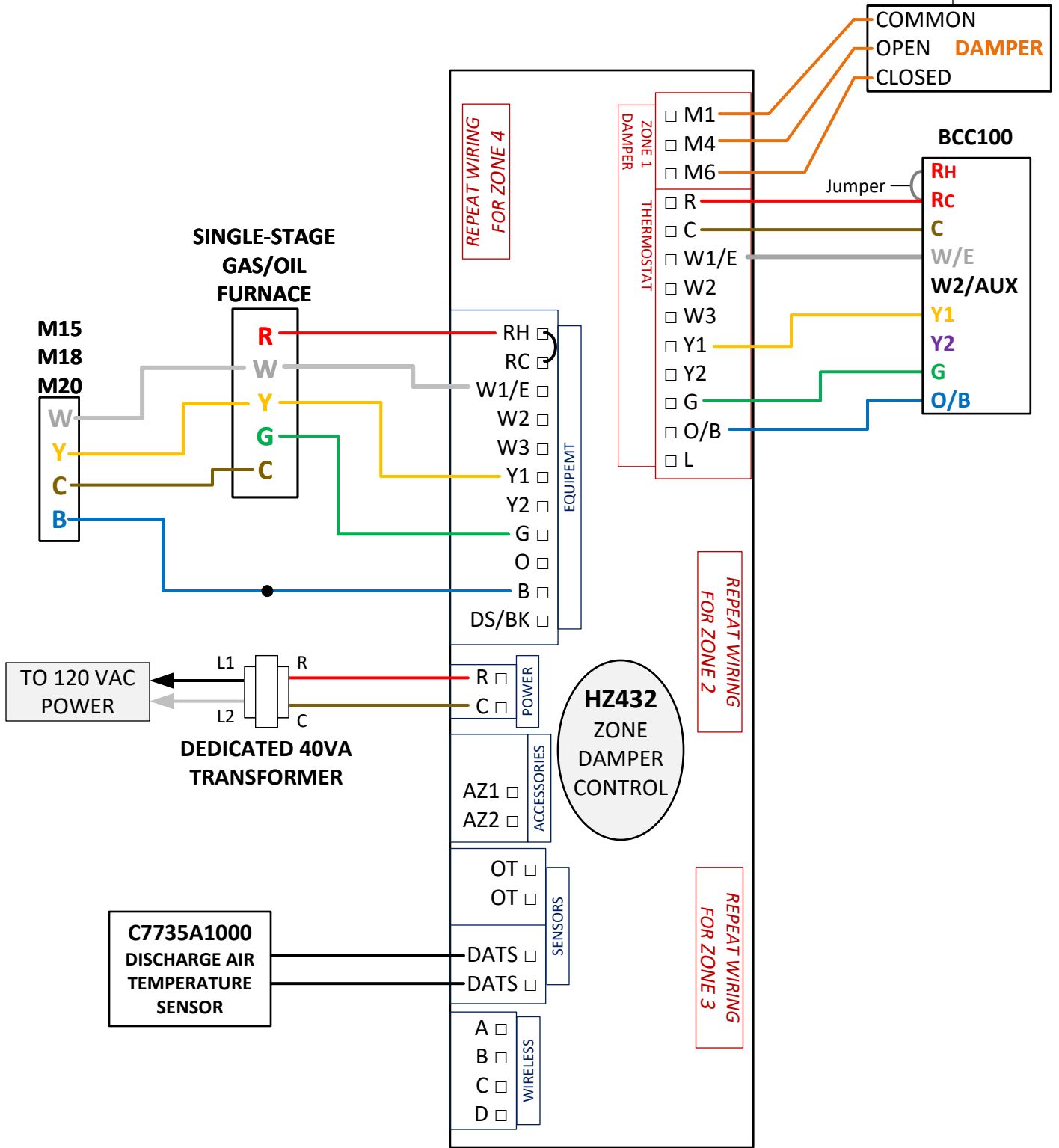

NOTES:

- For Dual Fuel Applications -

TSS Associates, Inc.

DESCRIPTION

BOSCH BCC100 – IDS – FURNACE – HONEYWELL HZ432

DATE: 1/4/2024

PAGE: 2 of 4

THERMOSTAT PARAMETERS:

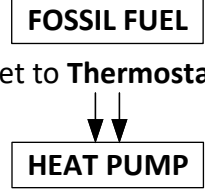
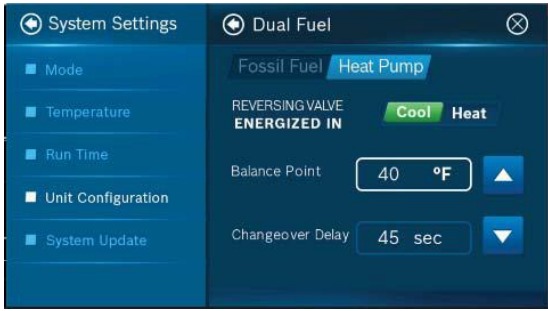
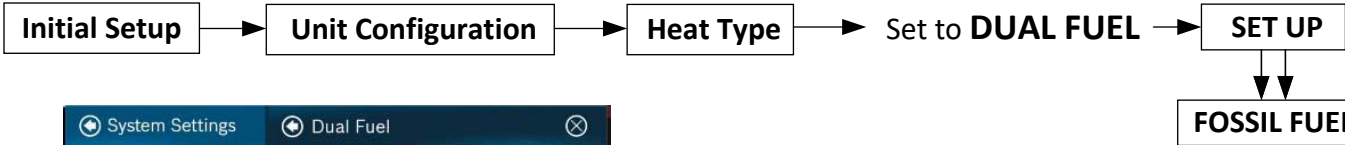

FAN CONTROL - Set to Thermostat

REVERSING VALVE - Set to Energized in Heat
BALANCE POINT - Set to Whatever temperature is desired based upon homeowner comfort and energy costs

CHANGEOVER DELAY - Set to 45sec

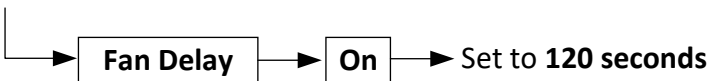
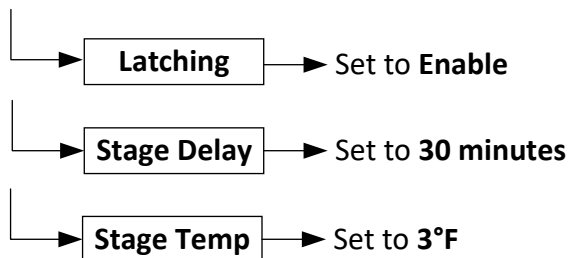
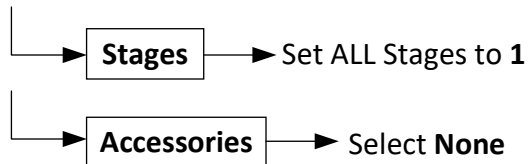

NOTES:

Bosch BGH96 Furnace W2 Delay:

S1-1	S1-2	S1-1	S1-2
ON	OFF	ON	ON
Sets to 10 minutes		Sets to 20 minutes	

TSS Associates, Inc.

DESCRIPTION
BOSCH BCC100 – IDS – FURNACE – HONEYWELL HZ432

DATE: 1/4/2024 PAGE: 3 of 4

ZONE CONTROL PARAMETERS:

SYSTEM TYPE: [HEATPUMP]
COMPRESSOR STAGES: [1]
DUAL FUEL OPERATION: [YES]
DFUEL HT STAGES: [1]
RF ENABLED: [NO] ****THIS OPTION IS ONLY USED IF YOU ARE INSTALLING WIRELESS CONTROLLERS****
ZONES INSTALLED: **SELECT APPROPRIATE NUMBER OF ZONES BEING USED**
ZONE1 TSTAT TYPE: [HTPUMP-B] → REPEAT THIS SELECTION FOR EACH ZONE
STAGE 2 CONTROL: [TSTAT]
STAGE 3 CONTROL: [OFF]
ADVANCED CONFIG? [YES] → HEAT FAN CONTROL: [HVAC]
DISCHARGE SENSOR: [YES]
DAT HIGH LIMIT: [145 F]
MSTG OT LOCKOUT: [NO]

SAVE CHANGES? [YES]

NOTES:

Bosch BGH96 Furnace W2 Delay:

S1-1	S1-2	S1-1	S1-2
ON	OFF	ON	ON
<i>Sets to 10 minutes</i>		<i>Sets to 20 minutes</i>	

TSS Associates, Inc.

DESCRIPTION

BOSCH BCC100 – IDS – FURNACE – HONEYWELL HZ432

DATE: 1/4/2024

PAGE: 4 of 4