



TSS Associates, Inc.



BOSCH

Invented for life

For further assistance, please contact
TSS Associates for Tech Support

518-621-7283

****IF WIRING MULTIPLE DAMPERS IN SERIES ON ONE ZONE, USE A DEDICATED TRANSFORMER AND ISOLATION RELAY AT EACH ZONE**

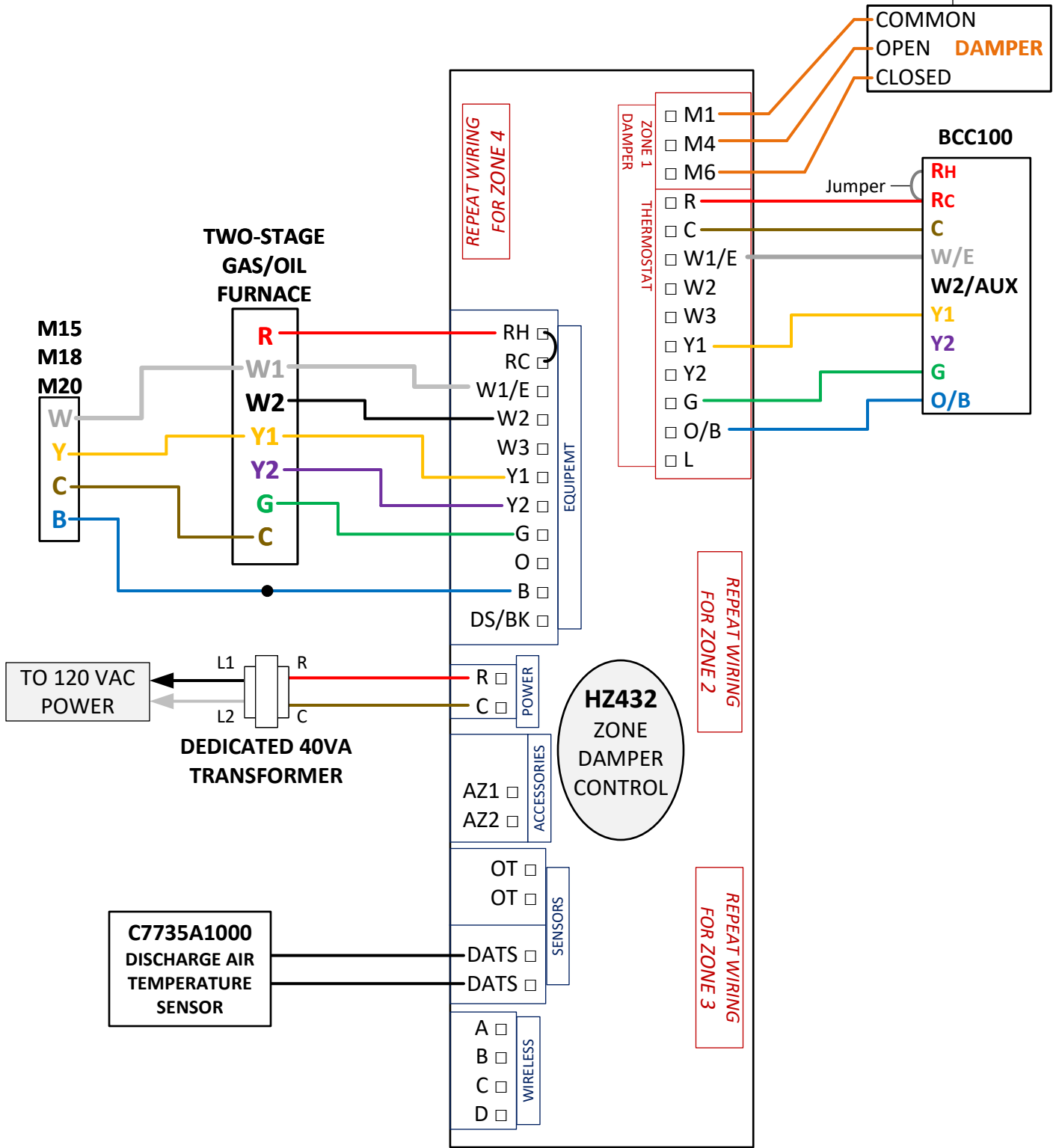

NOTES:

- For Dual Fuel Applications -

TSS Associates, Inc.

DESCRIPTION

BOSCH BCC100 – IDS – FURNACE – HONEYWELL HZ432

DATE: 1/4/2024

PAGE: 2 of 4

THERMOSTAT PARAMETERS:

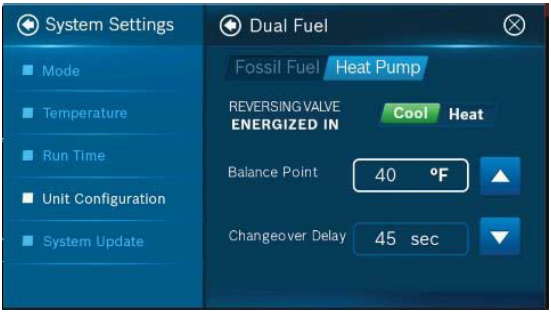
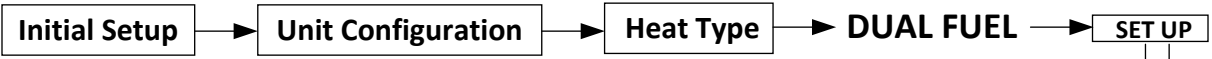

FOSSIL FUEL

FAN CONTROL - Set to Thermostat

HEAT PUMP

- REVERSING VALVE - Set to Energized in Heat
- BALANCE POINT - Set to Whatever temp is desired based on homeowner comfort and energy costs
- CHANGEOVER DELAY - Set to 45sec

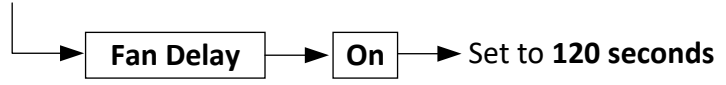
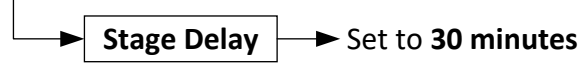
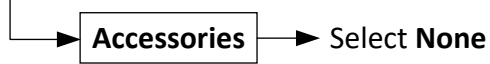
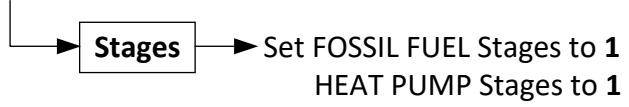

NOTES:

TSS Associates, Inc.

DESCRIPTION
BOSCH BCC100 – IDS – FURNACE – HONEYWELL HZ432

DATE: 1/4/2024 PAGE: 3 of 4

ZONE CONTROL PARAMETERS:

SYSTEM TYPE: [HEATPUMP]
COMPRESSOR STAGES: [2]
DUAL FUEL OPERATION: [YES]
DFUEL HT STAGES: [2]
RF ENABLED: [NO] ****THIS OPTION IS ONLY USED IF YOU ARE INSTALLING WIRELESS CONTROLLERS****
ZONES INSTALLED: **SELECT APPROPRIATE NUMBER OF ZONES BEING USED**
ZONE1 TSTAT TYPE: [HTPUMP-B] → REPEAT THIS SELECTION FOR EACH ZONE
STAGE 2 CONTROL: [TSTAT]
STAGE 3 CONTROL: [TSTAT]
ADVANCED CONFIG? [YES] → HEAT FAN CONTROL: [HVAC]
DISCHARGE SENSOR: [YES]
DAT HIGH LIMIT: [145 F]
MSTG OT LOCKOUT: [NO]

SAVE CHANGES? [YES]

NOTES:

TSS Associates, Inc.

DESCRIPTION

BOSCH BCC100 – IDS – FURNACE – HONEYWELL HZ432

DATE: 1/4/2024

PAGE: 4 of 4