



TSS Associates, Inc.



For further assistance, please contact
TSS Associates for Tech Support

518-621-7283

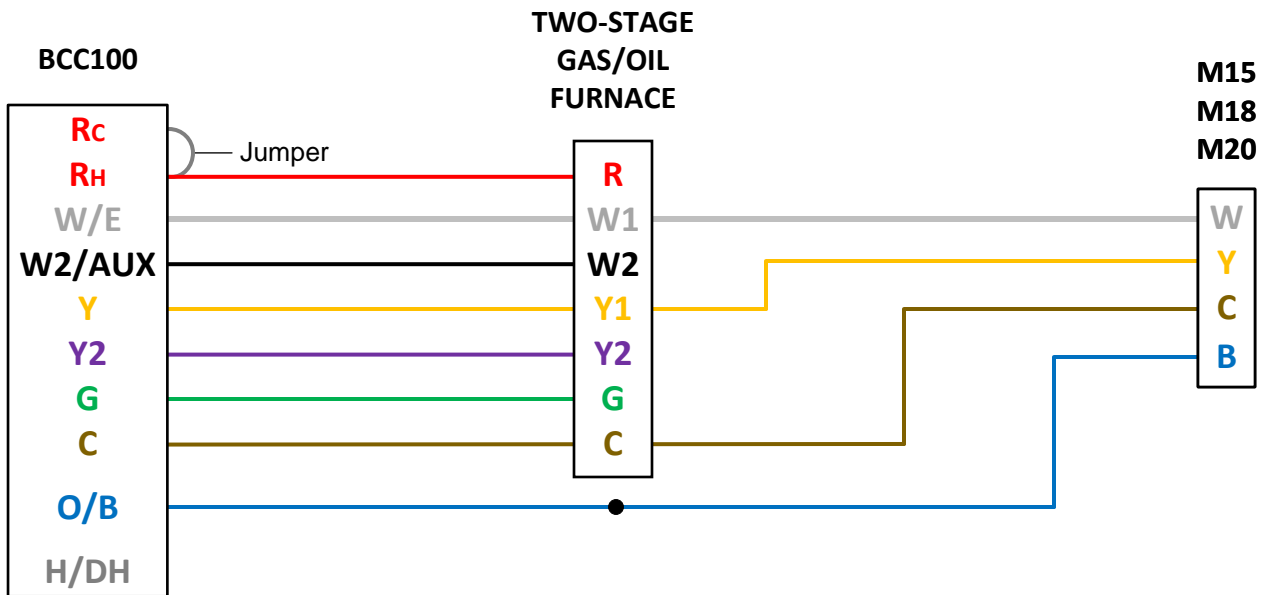

NOTES:

TSS Associates, Inc.

DESCRIPTION

BOSCH BCC100 – IDS – TWO-STAGE GAS/OIL FURNACE

DATE: 1/4/2024

PAGE: 2 of 4

PARAMETERS:

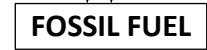
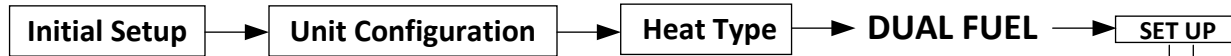

Fan Control - Set to **Thermostat**



Reversing Valve - Set to **Energized in Heat**

Balance Point - Set to **Whatever temperature is desired based upon homeowner comfort and energy costs**

Changeover Delay - Set to **45sec**

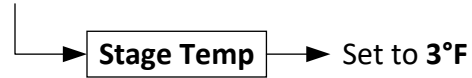
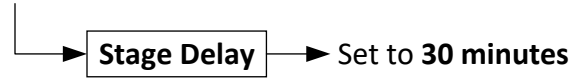
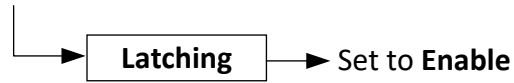
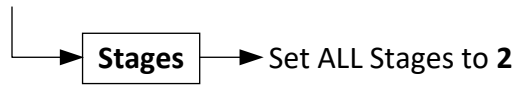

NOTES:

TSS Associates, Inc.

DESCRIPTION
BOSCH BCC100 – IDS – TWO-STAGE GAS/OIL FURNACE

DATE: 1/4/2024 PAGE: 3 of 4

PARAMETERS:

Advanced Settings

Heating & Cooling

Enter code **1886**

Fan Delay

On

Set to **120 seconds**



NOTES:

TSS Associates, Inc.

DESCRIPTION

BOSCH BCC100 – **IDS** – TWO-STAGE GAS/OIL FURNACE

DATE: 1/4/2024

PAGE: 4 of 4