



TSS Associates, Inc.



BOSCH

Invented for life

For further assistance, please contact
TSS Associates for Tech Support

518-621-7283

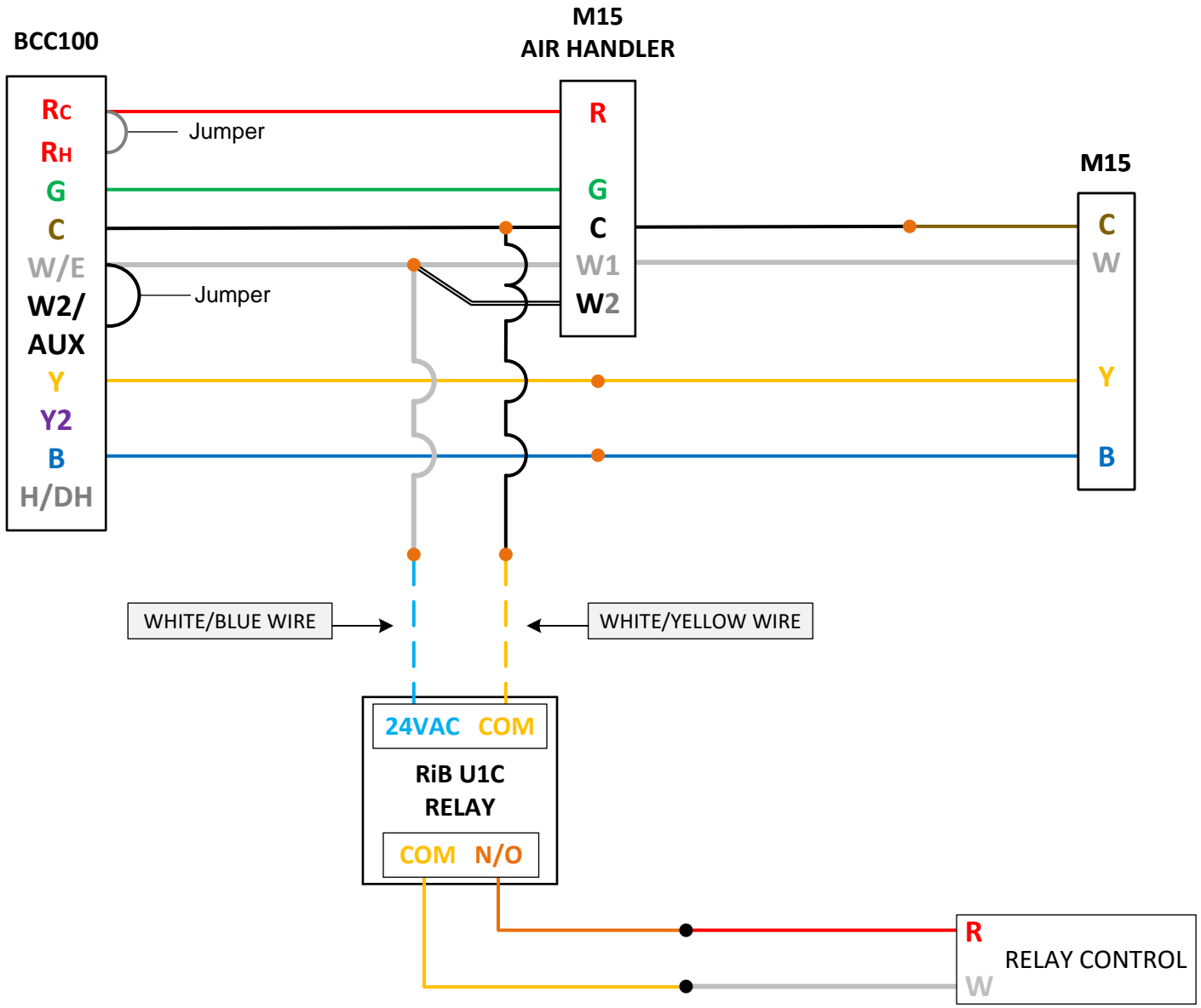

NOTES:

TSS Associates, Inc.

DESCRIPTION
 BOSCH BCC100 – M15 – M15 AHU – HYDRONIC COIL

DATE: 1/4/2024 PAGE: 2 of 3

PARAMETERS:

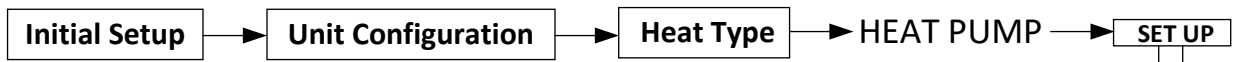

- Reversing Valve - Set to **Energized in Heat**
- Emergency Heat - Set to **Enabled**
- Auxiliary Heat - Set to **Enabled**

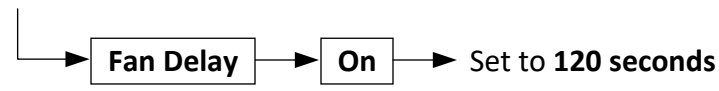
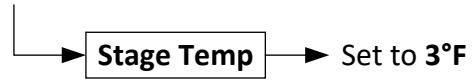
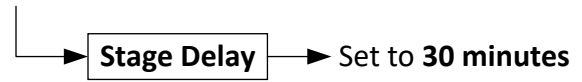
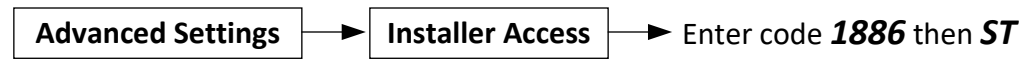
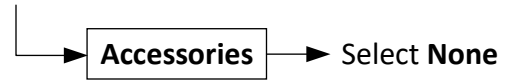
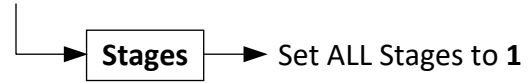

NOTES:

TSS Associates, Inc.

DESCRIPTION
BOSCH BCC100 – M15 – M15 AHU – HYDRONIC COIL

DATE: 1/4/2024 PAGE: 3 of 3